

# Operating Manual 0801

## Full HD Car DVR with GPS 2014



2014 model with switchable MPH and KPH

### Preface

## General precautions

- Do not expose this product to dusty, dirty or sandy areas to reduce the risk of damaging components.
- Do not expose the recorder to high temperature. High temperature may shorten the life span of electronic device, damage the battery and wind or melt specific plastic parts.
- Do not situate the recorder under cold environment. When the product is preheated to its correct temperature, there will be moisture inside and damage the circuit.
- Do not try to disassemble or repair by yourself. Doing so may lead to electric shock from the internal high-pressure components.
- Do not drop or punch the recorder. Otherwise the internal components will be damaged.
- Do not clean the recorder with chemicals, cleaning solution or high concentration detergent. Please wipe it with slightly damp soft cloth.
- Send the recorder or any other accessories to the professional service center for maintenance when they do not work well.
- According to the design, the camcorder should be operated within the temperature range from 0 degree to 40 degree (- 20°~ 65° centigrade)
- Do not operate or expose the camcorder under following condition:
  - Direct sunlight area
  - High temperature or dusty area
  - Near air conditioner or heaters or any other extreme temperature area
  - In a closure car, especially parking in direct sunlight
  - Violent vibration area

## Product Features

---

- 125 degree ultra wide angle lens.
- 1920x1080P FULL HD high quality resolution.
- 4 mega pixels.
- 4X digital zoom, still image 8X zoom.
- 1.5 inch high resolution LCD, can watching while recording.
- Advanced H.264 video compression technology.
- GPS, record the latitude and longitude data automatically. (Optional)
- Google map, to review your car tracking, speed and G-sensor info. (Optional)
- G-sensor, once device detect collision, the current file would be protected. (Optional)
- SOS function, to protect the important file in time.
- Seamless continuous recording will not miss any data.
- Automatically recording (stop recording) after car power on (off).
- Support AV out/ HDMI
- 30/60 frames per second for smooth video flow.
- Automatic circulating video recording, being able to set the record time for each file.
- Improve time & date display, no need reset when re-start.
- Screenshots function, can capture the video screen while video recording and reviewing.
- Easy operation.
- Micro SDHC, up to 32 GB (**Genuine Samsung 16gb class 6 tested & works perfectly**)

## 1. Brief Introduction of the Car Recorder

---

The features and functions are introduced in this chapter. In addition, PC system requirement, list of items and description of the hardware components are included.

## 1.1 PC System Requirements

The PC system needs to meet the following requirements:

- Windows XP/Vista/Win 7 operating system
- Intel Pentium 4 2.8GHz CPU or above (recommended 3GHz)
- At least 512 MB RAM or above (recommended 1GB)
- Standard USB2.0 port or above
- At least 64MB video card or above

## 1.2 Recorder appearance and feature icons

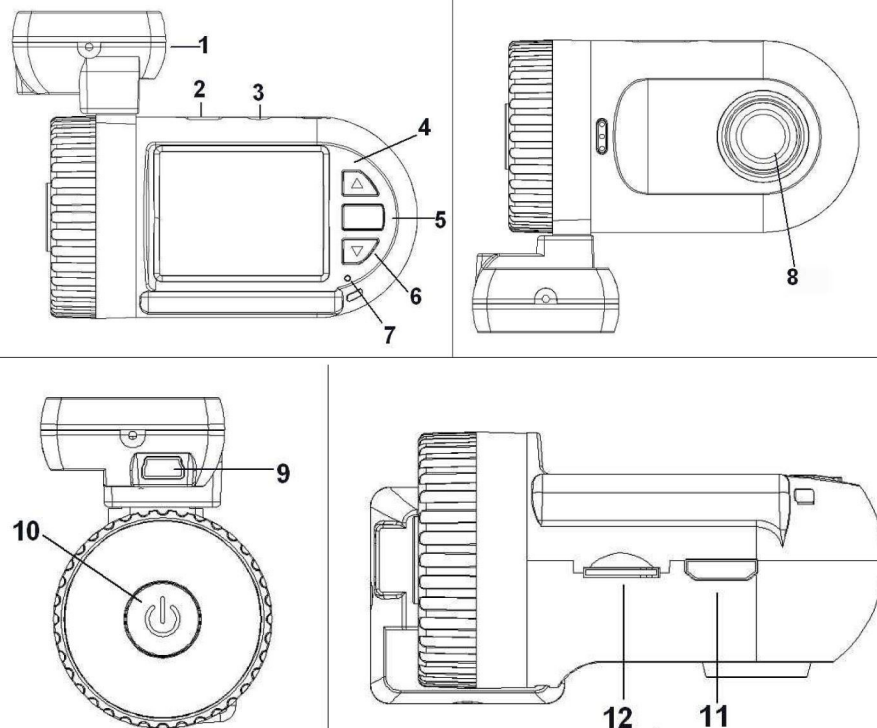

1. GPS tracker box also is a bracket; 3M sticker put here and then sticks to car front window. If no GPS, it is as a bracket only
2. USB port
3. AV port
4. UP / menu / mute
5. OK
6. Down / SOS
7. Light indicator
8. Lens
9. USB (working only when it with GPS tracker box)
10. Power on / off / reset (Long press it as reset button)
11. HDMI port
12. Micro SD card slot

## 2. Operation

---

Read this chapter to know how to operate the recorder.

### 2.1 Inserting a TF card

Inserting a TF card into the recorder provides more space to store videos, images or other files. Please use high-speed TF card meeting the specification of TFHC. (CLASS 4 or above, some Class 10 may cause some problem because the speed of card is too fast, Basic Model from SanDisk & LonDisk Class 10 tested to work reliably) other basic class 10 may also work.

### 2.2 Turning on your recorder

Press Power button to turn ON/ OFF the power. Or connect to the car charger, it will turn on when the car start.

### 2.3 Take a picture

2.3.1 On recording, long press "OK" button and take a picture

2.3.2 On standby, Long press "OK" button and take a picture

### 2.4 Reviewing the pictures

2.4.1 Long press "Down" button and into Movie reviewing, then long press "Down" button again and then you can review the pictures.

2.4.2 Then long press "up" button you can do something setting about the pictures: delete file/ protect file/auto play

2.4.3 Press "OK" button to confirm.

2.4.4 Long press "Down" button to back to other mode

### 2.5 Review/playing your video files

2.5.1 Long press "Down" button and into Movie reviewing to display the latest video files on the LCD screen.

2.5.2 Then long press "up" button you can do something setting about the video: delete file/protect file/auto play.

2.5.3 Press "OK" button to confirm.

2.5.4 Long press "Down" button twice to get back to other mode.

000:00:15	Playback time		Play
	Battery		Pause

### 2.6 Before using

#### 2.6.1 Setting Date and Time

Switch on the recorder. Press Menu (Long press up button), then press up and down button to choose Date and Time and press OK button to confirm.

#### 2.6.2 Setting Language

Switch on the recorder. Press Menu (Long press up button), then press up and down button to choose language and press OK button to confirm.

#### 2.6.3 Loop setting (OFF / 1 MIN / 3 MIN / 5MIN)

##### 2.6.3.1 On OFF mode

- The device cannot record automatically and cannot record by recycled.
- Maximum length of each recorded video file is 3.66G. When it reaches the maximum, the recording is

automatically split and saved as another file.

- If the space is full, the previous files will not be deleted; when card is full, will show “card full “ and cannot continue record.

### 2.6.3.2 When the loop setting mode is "1 MIN", "3 MIN", 5 MIN"

- When power on, the device will record automatically.
- If the space is full, the previous saved file will automatically cover and overwrite.

### 2.6.4 Setting other features

Read this chapter to know how to configure the setup and fine-tune the functions.

Switch on the recorder. Press Menu (Long time press up button), then press up and down button to choose the icons and press OK button to confirm. Press down

1. VIDEO RESOLUTION: FULL HD / 1080P30 / 720P30
2. PHOTO SIZE: 4M / 3M / 2M / 0.9M (Some sensors may be different)
3. SHARPNESS: STANDARD / HARD / SOFT
4. CONTRAST: STANDARD / HARD / SOFT
5. FLICKER: 50 / 60Hz (Use this function to set the flicker frequency in your area)
6. AE ISO: AUTO / 100 / 200 / 400
7. WHITE BALANCE: AUTO / SUNNY / CLOUDY / FLUORESCENT / INCANDESCENT (This item is for correction in different colors under different light conditions. When the white balance is set as AUTO, the camcorder compensates different light conditions automatically)
8. AE BIAS: -2 / -1.7 / -1.3 / -1 / -0.7 / -0.3 / 0 / 0.3 / 0.7 / 1 / 1.3 / 1.7 / 2
9. AE METER MODE: CENTER / AVERAGE / SPOT
10. TV TYPE: NTSC / PAL
11. AUTO POWER OFF: OFF / 1 MIN / 3 MIN / 5 MIN
12. TIME SETUP: 00GMT+- YYYY.MM.DD
13. DATE TIME DISPLAY: OFF / DATE / TIME / DATE TIME
14. LOOP SETTING: 1 MIN / 3 MIN / 5 MIN / OFF
15. MOTION DETECT: OFF / ON
16. STAMP: DRIVER NUMBER / OFF / DATE / TIME / DATE TIME / CAR (When you choose DATE TIME and CAR, then DRIVER NUMBER cannot not show, there is not enough space. Under CAR mode, it will display the location latitude and longitude after connect to GPS. When you choose DATE TIME and DRIVER NUMBER, then GPS information cannot show, there is not enough space. DRIVER NUMBER option 9 characters for driver's number or license plate number.)
17. DRIVER NUMBER: 000000000
18. POWER OFF SCREEN: 1 MIN / 3 MIN / 5 MIN / OFF
19. VIDEO RECORDER MODE: VIDEO AUDIO / VIDEO
20. GPS: OPEN (on) / CLOSE (off)
21. G-SENSOR PRECISION: 2.5G / 3G / 3.5G / 4G / 4.5G / 5G / CLOSE
22. G-SENSOR CALIBRATION: NO / YES
23. VELOCITY: V: = MPH/KPH/ SET OK
24. USB MODE: MASS STORAGE / USB CAMERA
25. LANGUAGE: ENGLISH / RUSSIAN
26. DEFAULT SETTING: NO / YES (This function will restore all the settings to the factory defaults.)
27. FORMAT: NO / YES
28. FIRMWARE VERSION

## 2.7 Connecting PC

Connect the DVR to your computer with USB cable included. (Effective only with recording set to off)  
When the DVR is connected with PC, it appears as a removable disk in the Windows explorer/ My computer.  
The DVR screen turns Blue in USB mode, This is normal.

## 2.8 Connecting the DVR to Standard TV. (Effective with AV-OUT function)

Connect your recorder and Standard TV via Accessory AV cables.

## 2.9 Connecting the DVR to HDTV

When connecting to HDTV, you can use high resolution to display video files or pictures.  
Use HDMI cable to connect the camcorder video or audio signal to HDTV.

### Attention:







When connected to HDTV, shuttering, recording and taping are not available!

## 2.10 Recording Mode

This mode is for recording a video or tacking picture file. The files are saved into TF card.

## 2.11 Icons meanings

Indication of each icon and symbol, see the table below.

	Video Mode		Battery & charge state
	TF Card (micro SD)		Motion Detection
V:-----	Car speed monitor after GPS has found the satellite		White Balance Auto, Tungsten, Fluorescent, Daylight, Cloudy indicator
FULL HD	Resolution	2013/01/01 01: 08AM	Date and Time
	Segmented loop recording time 1,3,5		GPS active.

## 2.12 File Protection

### 2.12.1 When reviewing the video,

- Long press "Down" button and into Movie reviewing to display the latest video files on the LCD screen.
- Then long presses "up" button you can move to protect file button then setup protect one file or all, etc. The file with  are protected.
- Press "OK" button to confirm.
- Long press "Down" button twice to get back to other mode.

### 2.12.2 When recording (SOS)

Press DOWN button and the current file will be saved and locked and cannot be deleted. 

**Attention:** To unlock the files, repeat the steps above. After being unlocked, no files are marked with a lock mark; under Loop record setting, the previous file is not protected, protects only the last cycle

When you copy the video to another memory or HDD, the copied file will still be locked.

## 2.13 GPS (Optional)

**GPS tracking (effective with GPS-IN OPEN function) for the model with GPS Base; if you have the none GPS base you cannot use this function.**

- Power on your DVR, the satellite searching will be start automatically. When GPS signal is located, the symbol  will be showed on the display. When GPS signal is located, the DVR will auto record your driving track and entry the GPS file in your TF card.
- Car Speed,  
When GPS signal is located, the screen will display the car speed V:----MP/H OR V:---- KM/H (you can change this setting in the menu under Velocity)
- Google Map,  
With our special player, you can see your car tracking in the Google Maps clearly, the player also shows you the vehicle speed and G-Sensor information. See picture 1.

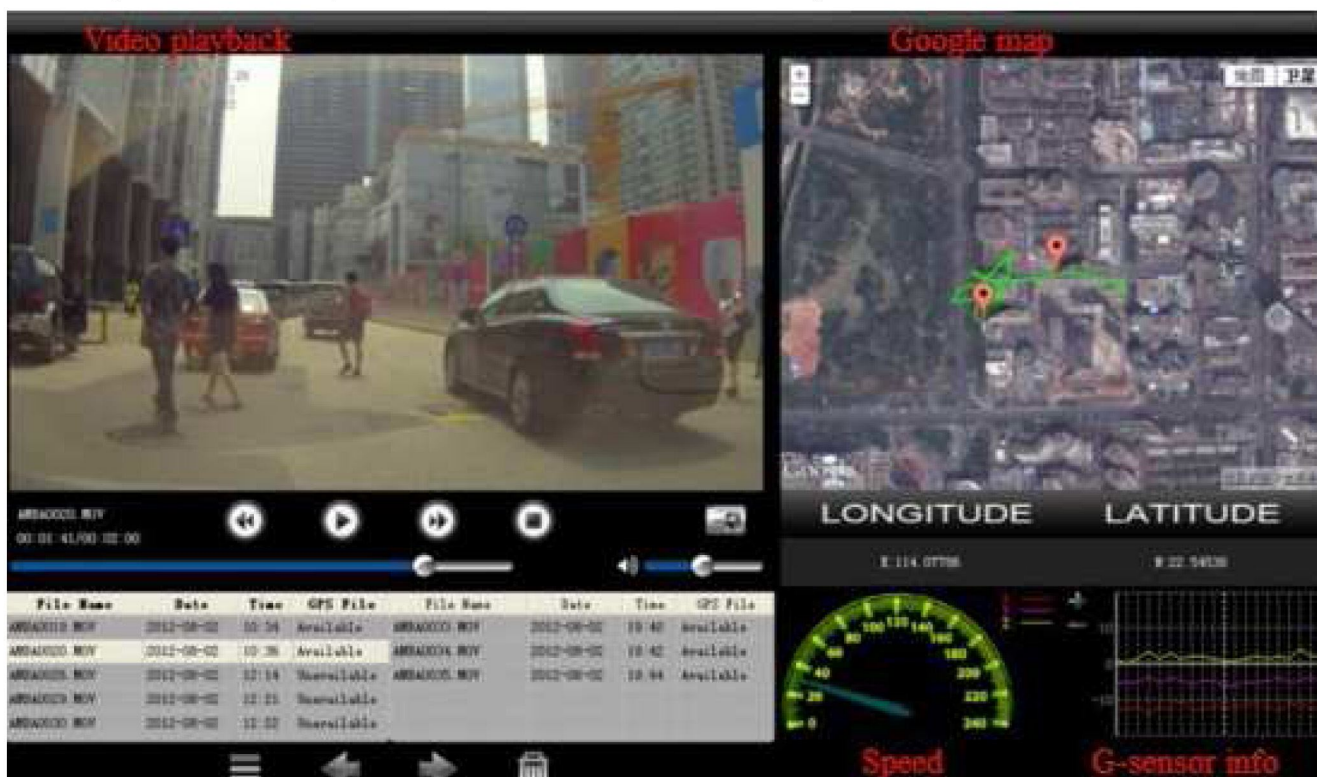



**Video Player: (some other players can make the file jerky) please use the supplied player.**

### 1. How to get the video player drive:

- Insert the CD Supplied or if you have no cd Connect the DVR machine (without card) with computer.
- Take a look in "My computer" for the CD Disk & Car Player file or in the DVR for Car Player file
- Open it, and copy the file  to a new folder on your desktop (or other place, but please remember the place). Double-click to decompress the file, you will get a folder SPEED\_UNIT open this and Go to EN in this folder.

### 2. Google Map:

- Find the GPS player  in the folder, open it, you will get a GPS player with Google maps (as picture 1)
- After you record the video with GPS, connect your Micro SD or your DVR with computer, Browse to your video files with this button  at the bottom of your GPS player, then choose your Micro SD card browse to →DCIM→100MEDIA, then choose the video/s you want. (the GPS will automatically load).

**2.14 Light indicator:** Red light: charging      Blue light: stand by      Blue flashing: recording

Red light: charging+ Blue light: standby can appear purple, this is normal as they are in the same window.

### 3. Appendix

#### 3.1 Specification

Display	1.5" TFT (480×240 pixels)
GPS Module	GPS LOGGER
Memory	Micro SD card (SDHC up to 32 G)
Lens	Fixed Focus wide angle lens (120°)
ISO	Auto
Still images	Format: JPEG(EXIF2.2), DCF Image resolution: 0.9M, 2M, 3M(software), 4M(software)
Videos	Format: H.264 (MOV) Resolution: 1920×1080 30fps, 1440×1080 30fps, 1280×720 30fps
Zoom	Video: 4X Digital Zooming(1440*1080P) Playback still image: Digital Zoom 8X (Maximum)
Audio	Built-in microphone/ speaker
Exposure compensation	-2.0EV~+2.0EV
Loop Recording	OFF, 1 MIN, 3 MIN, 5 MIN
Auto Power Off	OFF, 1 MIN, 3 MIN, 5 MIN
Auto power off screen	OFF, 1 MIN, 3 MIN, 5 MIN
PC Interface	USB2.0 (High-speed)
Output	HDMI , Audio-Video output
AV Output Format	NTSC/PAL
Battery	Built-in polymer battery 3.7V

#### 3.2 Troubleshooting

Question	Possible reasons	Solutions
The camcorder is suddenly turned off	Auto Off Function is On. Low battery	Turn on again the recorder Charge battery
Captured images are not saved into memory	Power is off before the images are saved.	Charge battery
Memory card cannot be used	Memory card is protected. Memory card contains non-DCF images from other cameras.	Unlock the memory card. Format the memory card. Before formatting, make sure to backup files first.
All the buttons are invalid.	Short-circuit when connecting camcorder with other equipments.	Long press the power button 9-10 seconds to re-boot



### 3.3 Recorder Package Contents:

Article Name	Quantity (PCS)
Recorder	1
Car Adapter (Output: 5V)	1
USB cable	1
3M sticker	1
Car Fixed Bracket	1
User Manual	1
CD disk	1

NOTE: Alterations reserved.

#### **About the Manual**

We have tried our best to make sure that what in this manual is right and updated. However, we cannot guarantee that all the content is correct without any errors. If there is a difference between the manual and recorder, please take the recorder as standard. We keep the right to change content or

technical regulations without informing you beforehand. In addition, the manufacturer keeps the right to change technical specification without informing you beforehand.

If the accessories are different from the ones inside the actual product, please take the actual product as standard.